

VISTA FRONTAL

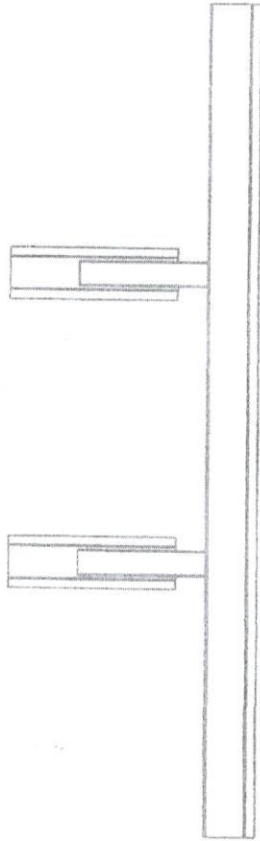

VISTA LATERAL

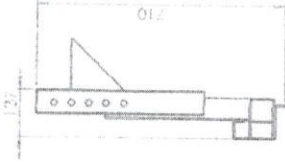

ITEM 6  
PEÇA 04  
02 UNIDADES  
CH. 3/16"

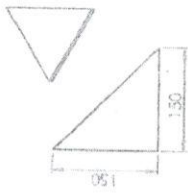

ITEM 5  
PEÇA 06  
02 UNIDADES  
CH. 3/16"

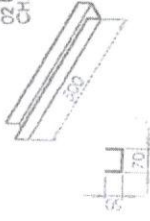

VISTA SUPERIOR



ITEM 4  
PEÇA 05  
01 UNIDADE  
CH. 3/16"

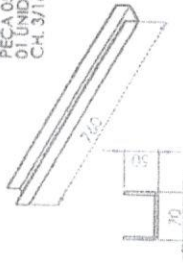

ITEM 2  
PEÇA 03  
02 UNIDADES  
CH. 3/16"

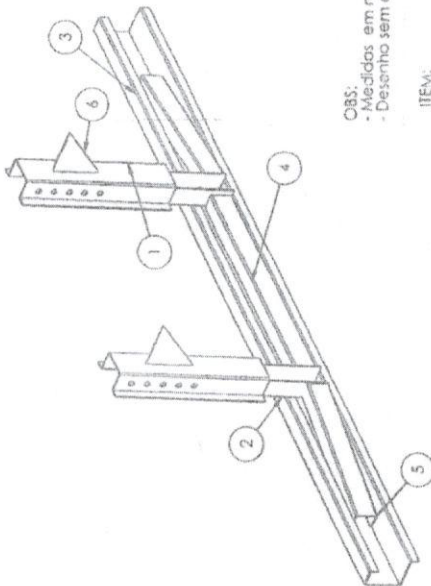
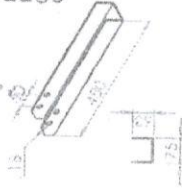

ITEM 1  
PEÇA 02  
02 UNIDADES  
CH. 3/16"

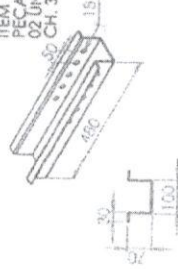

ITEM 3  
PEÇA 01  
01 UNIDADE  
CH. 3/16"

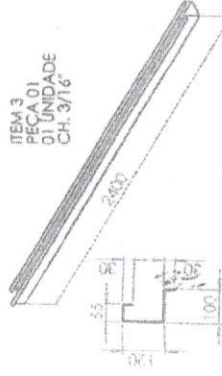

OBS:  
- Medidas em mm  
- Desenho sem escalas

ITEM NO.	PEÇA	MATERIAL	QTD.	PESO (kg)
1	Peça 02	SAE 1020	2	10,0
2	Peça 03	SAE 1020	2	7,5
3	Peça 01	SAE 1020	1	27,0
4	Peça 05	SAE 1020	1	4,4
5	Peça 06	SAE 1020	2	5,8
6	Peça 04	SAE 1020	2	0,9

REVISÃO: 1

NÚMERO:

EDFA-00003

Para Choque 2400 x 4,75

CNPJ:

11.630.939/0001-56

PROPRIETÁRIO:

Eiderado Distribuidora de Ferro e Aço Ltda EPP

RESPONSÁVEL TÉCNICO:

Anderson Scalcon / Engenheiro Mecânico / CREA-SC 108966-0

LOCAL/DATA:

Chapecô/SC, 16 de Janeiro de 2017

*Anderson Scalcon*  
 Anderson Scalcon  
 Eng. Mecânico  
 CREA-SC 108966-0